

JG1A25P120FG2

Product Preview

**1200V/25A PIM WITH
FIELD-STOP TRENCH IGBT, DIODE AND NTC**

Features

- Low $V_{CE(sat)}$
- Fast Switching
- High Ruggedness
- Short-Circuit Rated



Product Summary	
V_{CES}	1200V
I_c	25A
$V_{CE(sat),typ}$	1.85V ($T_J = 25^\circ\text{C}$)

Applications

- General Purpose Inverters
- Frequency Converters
- Industrial Motor Drives
- Servos

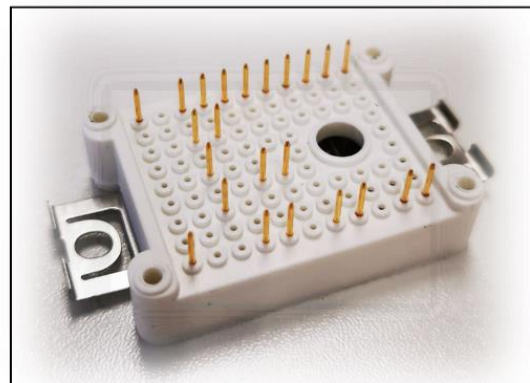
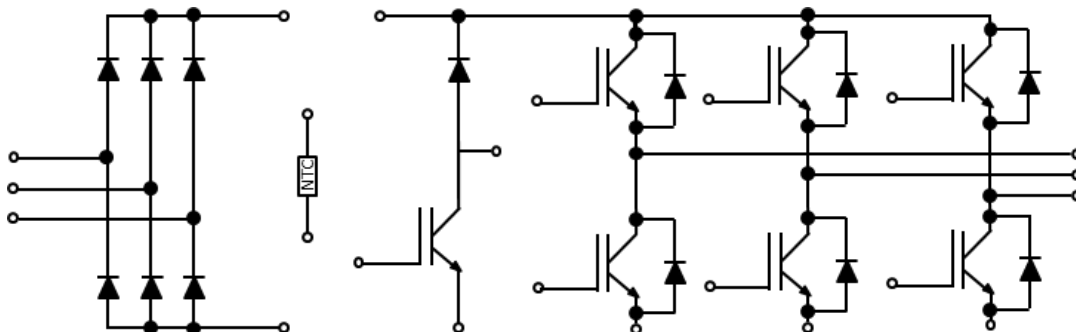
Internal Connection

- **IGBT, Inverter**

Absolute Maximum Ratings

Parameter	Symbol	Limit	Unit
Collector-to-Emitter Voltage	V_{CES}	1200	V
Gate-to-Emitter Voltage	V_{GES}	± 20	
Continuous DC Collector Current ($T_c = 100^\circ\text{C}$, $T_J = 175^\circ\text{C}$)	I_{CDC}	25	A
Repetitive Peak Collector Current ($t_p=1\text{ms}$)	I_{CRM}	50	

Electrical Characteristics ^{(1), (2)}

Parameter	Symbol	Test Conditions	Min	Typ	Max	Unit
Collector-to-Emitter Breakdown Voltage	BV_{CES}	$V_{GE} = 0V, I_C = 250\mu A$	1200	-	-	V
Collector-to-Emitter Leakage Current	I_{CES}	$V_{CE} = 1200V, V_{GE} = 0V$	-	-	1	mA
Gate-to-Emitter Leakage Current	I_{GES}	$V_{CE} = 0V, V_{GE} = \pm 20V$	-	-	100	nA
Gate Threshold Voltage	$V_{GE(th)}$	$V_{CE} = V_{GE}, I_C = 600\mu A$	5.5	6.5	7.5	V
Collector-to-Emitter Saturation Voltage	$V_{CE(sat)}$	$V_{GE} = 15V, I_C = 25A$	-	1.85	2.2	
		$V_{GE} = 15V, I_C = 25A, T_J = 125^\circ C$	-	2.3	-	
		$V_{GE} = 15V, I_C = 25A, T_J = 150^\circ C$	-	2.4	-	
Total Gate Charge	Q_g	$V_{CC} = 600V, V_{GE} = 15V, I_C = 25A$	-	105	-	nC
Input Capacitance	C_{iss}	$V_{CE} = 25V, V_{GE} = 0V, f = 1MHz$	-	1980	-	pF
Output Capacitance	C_{oss}		-	110	-	
Reverse Transfer Capacitance	C_{rss}		-	20	-	
Turn-on Delay time	$t_{d(ON)}$	$V_{CC} = 600V, V_{GE} = 0/15V, R_G = 15\Omega, I_C = 25A, L_{load} = 0.82mH, \text{Energy losses include "tail" and diode reverse recovery.}$	-	40	-	ns
Rise Time	t_r		-	45	-	
Turn-off Delay time	$t_{d(OFF)}$		-	190	-	
Fall Time	t_f		-	120	-	
Turn-On Switching Loss	E_{on}		-	1.75	-	mJ
Turn-Off Switching Loss	E_{off}		-	1.15	-	
IGBT Total Switching Loss	E_{ts}		-	2.9	-	
Turn-on Delay time	$t_{d(ON)}$	$V_{CC} = 600V, V_{GE} = 0/15V, R_G = 15\Omega, I_C = 25A, L_{load} = 0.82mH, \text{Energy losses include "tail" and diode reverse recovery. } T_J = 150^\circ C$	-	45	-	ns
Rise Time	t_r		-	48	-	
Turn-off Delay time	$t_{d(OFF)}$		-	240	-	
Fall Time	t_f		-	170	-	
Turn-On Switching Loss	E_{on}		-	2.9	-	mJ
Turn-Off Switching Loss	E_{off}		-	1.45	-	
IGBT Total Switching Loss	E_{ts}		-	4.35	-	
Short Circuit Collector Current	$I_{C(SC)}$	$V_{GE} = 15V, V_{CC} \leq 600V, t_{SC} \leq 10\mu s$	-	85	-	A

- **Diode, Inverter**

Absolute Maximum Ratings

Parameter	Symbol	Limit	Unit
Repetitive Peak Reverse Voltage	V_{RRM}	1200	V
Continuous DC Forward Current	I_F	25	A
Repetitive Peak Forward Current ($t_p=1ms$)	I_{FRM}	50	

Electrical Characteristics ⁽¹⁾

Parameter	Symbol	Test Conditions	Min	Typ	Max	Unit
Diode Forward Voltage	V_F	$I_F = 25A$	-	2.4	2.9	V
		$I_F = 25A$ $T_J = 125^\circ C$	-	2.1	-	
		$I_F = 25A$ $T_J = 150^\circ C$	-	2.0	-	
Diode Reverse-Recovery Charge	Q_{rr}	$V_R = 600V, I_F = 25A,$ $di_F/dt = -455 A/\mu s$	-	1.5	-	μC
Diode Peak Reverse-Recovery Current	I_{rrm}		-	15.0	-	A
Diode Reverse-Recovery Loss	E_{rr}		-	0.55	-	mJ

- **IGBT, Brake-Chopper**

Absolute Maximum Ratings

Parameter	Symbol	Limit	Unit
Collector-to-Emitter Voltage	V_{CES}	1200	V
Gate-to-Emitter Voltage	V_{GES}	± 20	
Continuous DC Collector Current ($T_c = 100^\circ C, T_J = 175^\circ C$)	I_{CDC}	25	A
Repetitive Peak Collector Current ($t_p=1ms$)	I_{CRM}	50	

Electrical Characteristics ^{(1), (2)}

Parameter	Symbol	Test Conditions	Min	Typ	Max	Unit
Collector-to-Emitter Breakdown Voltage	BV_{CES}	$V_{GE} = 0V, I_C = 250\mu A$	1200	-	-	V
Collector-to-Emitter Leakage Current	I_{CES}	$V_{CE} = 1200V, V_{GE} = 0V$	-	-	1	mA
Gate-to-Emitter Leakage Current	I_{GES}	$V_{CE} = 0V, V_{GE} = \pm 20V$	-	-	100	nA
Gate Threshold Voltage	$V_{GE(th)}$	$V_{CE} = V_{GE}, I_C = 600\mu A$	5.5	6.5	7.5	V
Collector-to-Emitter Saturation Voltage	$V_{CE(sat)}$	$V_{GE} = 15V, I_C = 25A$	-	1.85	2.2	

		$V_{GE} = 15V, I_C = 25A,$ $T_J = 125^\circ C$	-	2.3	-	
		$V_{GE} = 15V, I_C = 25A,$ $T_J = 150^\circ C$	-	2.4	-	
Total Gate Charge	Q_g	$V_{CC} = 600V,$ $V_{GE} = 15V,$ $I_C = 25A$	-	105	-	nC
Input Capacitance	C_{iss}	$V_{CE} = 25V,$	-	1980	-	pF
Output Capacitance	C_{oss}	$V_{GE} = 0V,$	-	110	-	
Reverse Transfer Capacitance	C_{riss}	$f = 1MHz$	-	20	-	
Turn-on Delay time	$t_{d(ON)}$	$V_{CC} = 600V,$ $V_{GE} = 0/15V,$ $R_G = 15\Omega,$ $I_C = 25A,$ $L_{load} = 0.82mH,$ Energy losses include "tail" and diode reverse recovery.	-	40	-	ns
Rise Time	t_r		-	45	-	
Turn-off Delay time	$t_{d(OFF)}$		-	190	-	
Fall Time	t_f		-	120	-	
Turn-On Switching Loss	E_{on}		-	1.75	-	
Turn-Off Switching Loss	E_{off}	-	1.15	-		
IGBT Total Switching Loss	E_{ts}	-	2.9	-		
Turn-on Delay time	$t_{d(ON)}$	$V_{CC} = 600V,$ $V_{GE} = 0/15V,$ $R_G = 15\Omega,$ $I_C = 25A,$ $L_{load} = 0.82mH,$ Energy losses include "tail" and diode reverse recovery. $T_J = 150^\circ C$	-	45	-	ns
Rise Time	t_r		-	48	-	
Turn-off Delay time	$t_{d(OFF)}$		-	240	-	
Fall Time	t_f		-	170	-	
Turn-On Switching Loss	E_{on}		-	2.9	-	mJ
Turn-Off Switching Loss	E_{off}		-	1.45	-	
IGBT Total Switching Loss	E_{ts}		-	4.35	-	
Short Circuit Collector Current	$I_{C(SC)}$	$V_{GE} = 15V,$ $V_{CC} \leq 600V,$ $t_{SC} \leq 10\mu s$	-	85	-	A

• Diode, Brake-Chopper

Absolute Maximum Ratings

Parameter	Symbol	Limit	Unit
Repetitive Peak Reverse Voltage	V_{RRM}	1200	V
Continuous DC Forward Current	I_F	10	A
Repetitive Peak Forward Current ($t_p=1ms$)	I_{FRM}	20	

Electrical Characteristics ⁽¹⁾

Parameter	Symbol	Test Conditions	Min	Typ	Max	Unit
Diode Forward Voltage	V_F	$I_F = 10A$	-	2.2	2.65	V
		$I_F = 10A$ $T_J = 125^\circ C$	-	1.8	-	
		$I_F = 10A$ $T_J = 150^\circ C$	-	1.7	-	
Diode Reverse-Recovery Charge	Q_{rr}	$V_R = 600V, I_F = 10A,$ $dI_F/dt = -600 A/\mu s$	-	0.8	-	μC
Diode Peak Reverse-Recovery Current	I_{rrm}		-	11.0	-	A
Diode Reverse-Recovery Loss	E_{rr}		-	0.22	-	mJ

- **Diode, Rectifier**

Absolute Maximum Ratings ⁽¹⁾

Parameter	Symbol	Limit	Unit
Repetitive Peak Reverse Voltage	V_{RRM}	1600	V
Average Output Current 50/60Hz,sine wave ($T_c = 100^\circ C$)	$I_{F(AV)}$	20	A
Maximum RMS Current at Rectifier Output ($T_c = 100^\circ C$)	I_{RMSM}	40	
Surge Forward Current ($V_R=0, t_p=10ms$)	I_{FSM}	270	
I^2t – value ($V_R=0, t_p = 10 ms$)	I^2t	360	A^2s

Electrical Characteristics

Parameter	Symbol	Test Conditions	Min	Typ	Max	Unit
Diode Forward Voltage	V_F	$I_F = 15A$ $T_J = 150^\circ C$	-	0.96	-	V
Diode Reverse Current	I_R	$V_R = 1600V$ $T_J = 150^\circ C$	-	-	1.0	mA

- **NTC thermistors**

Characteristics

Parameter	Symbol	Test Conditions	Min	Typ	Max	Unit
Rated Resistance	R_{25}		-	5.0	-	k Ω
Deviation of R100	$\Delta R/R$	$T_c = 100^\circ C$ $R_{100} = 493.3\Omega$	-5	-	5	%
Power Dissipation	P_{25}		-	-	20.0	mW
B-value	$B_{25/50}$	$R_2 = R_{25} \exp [B_{25/50}(1/T_2 - 1/(298.15 K))]$	-	3375	-	K

- **Module**

Absolute Maximum Ratings

Parameter	Symbol	Limit	Unit
Maximum Junction Temperature	T_j	-40 to +175	°C
Operating Junction Temperature	$T_{vj\ op}$	-40 to +150	
Storage Temperature	T_{stg}	-40 to +150	
Isolation Voltage (f = 50 Hz, t = 1 min)	V_{iso}	2.5	kV

Characteristics

Parameter	Symbol	Min	Typ	Max	Unit
Stray Inductance-module	L_{SCE}	-	30	-	nH
Module Lead Resistance, Terminal to Chip	$R_{CC'+EE'}$	-	8.0	-	mΩ
Module Lead Resistance, Terminal to Chip	$R_{AA'+CC'}$	-	6.0	-	
Junction-to-Case Thermal Resistance, per IGBT, Inverter	$R_{\theta JC}$	-	0.95	-	°C/W
Junction-to-Case Thermal Resistance, per Diode, Inverter		-	1.30	-	
Junction-to-Case Thermal Resistance, per IGBT, Brake-Chopper		-	0.95	-	
Junction-to-Case Thermal Resistance, per Diode, Brake-Chopper		-	1.75	-	
Junction-to-Case Thermal Resistance, per Diode, Rectifier		-	1.03	-	
Case-to-Heatsink Thermal Resistance, per IGBT, Inverter	$R_{\theta CH}$	-	0.95	-	°C/W
Case-to-Heatsink Thermal Resistance, per Diode, Inverter		-	1.02	-	
Case-to-Heatsink Thermal Resistance, per IGBT, Brake-Chopper		-	0.95	-	
Case-to-Heatsink Thermal Resistance, per Diode, Brake-Chopper		-	1.30	-	
Case-to-Heatsink Thermal Resistance, per Diode, Rectifier		-	1.17	-	
Case-to-Heatsink Thermal Resistance, per Module		-	0.058	-	
Mounting Force per Clamp	F	20	-	50	N
Weight per Module	G	-	25	-	g

(1) $T_j = 25^\circ\text{C}$ unless otherwise specified

(2) t_r : from 10% of I_c to 90% of I_c ; t_f : from 90% of I_c to 10% of I_c ;

E_{on} : from 10% of V_{GE} to 10% of V_{CE} ; E_{off} : from 90% of V_{GE} to 10% of I_c .

• Typical Electrical Characteristics

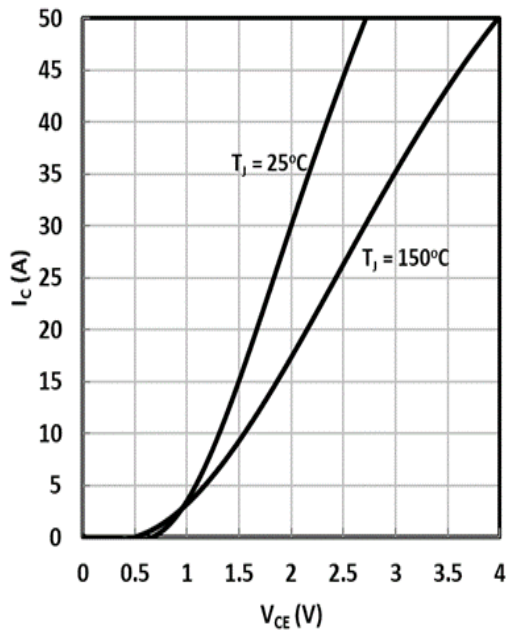

Fig. 1 IGBT (Inverter) Output Characteristics

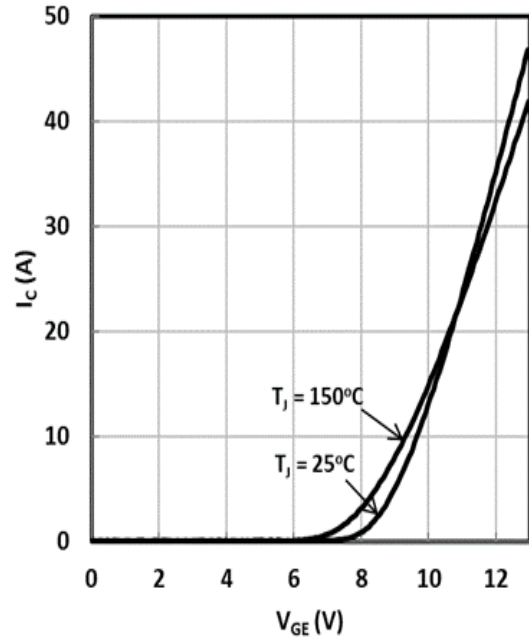

Fig. 2 IGBT (Inverter) Transfer Characteristics

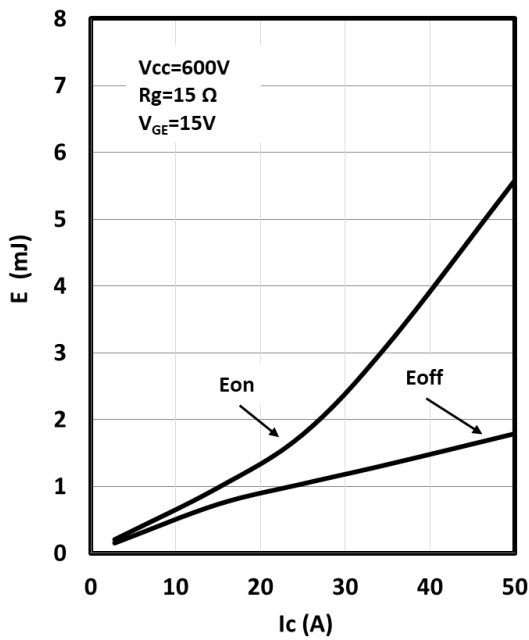

Fig. 3 IGBT (Inverter) Switching Loss vs. Ic

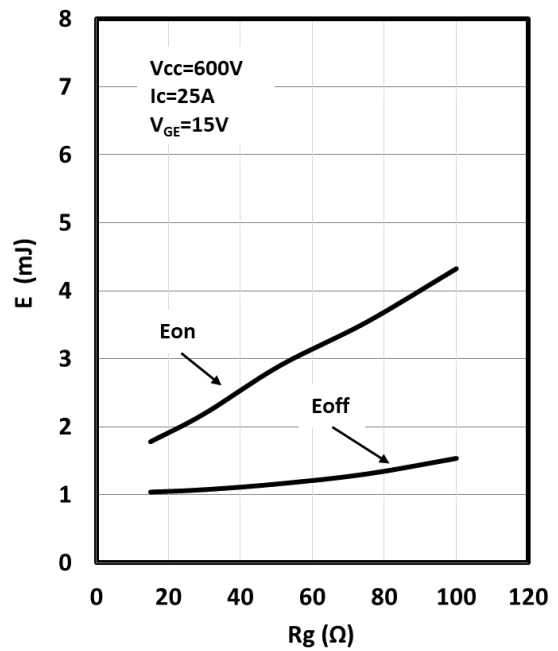

Fig. 4 IGBT (Inverter) Switching Loss vs. Rg

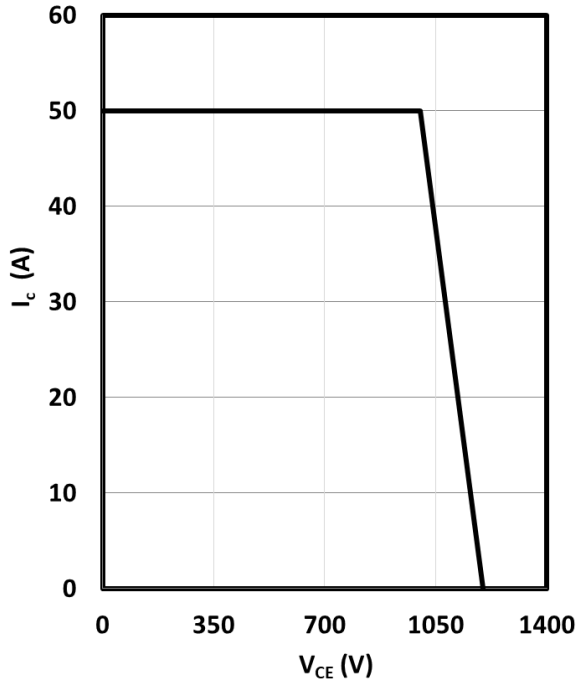

Fig. 5 RBSOA

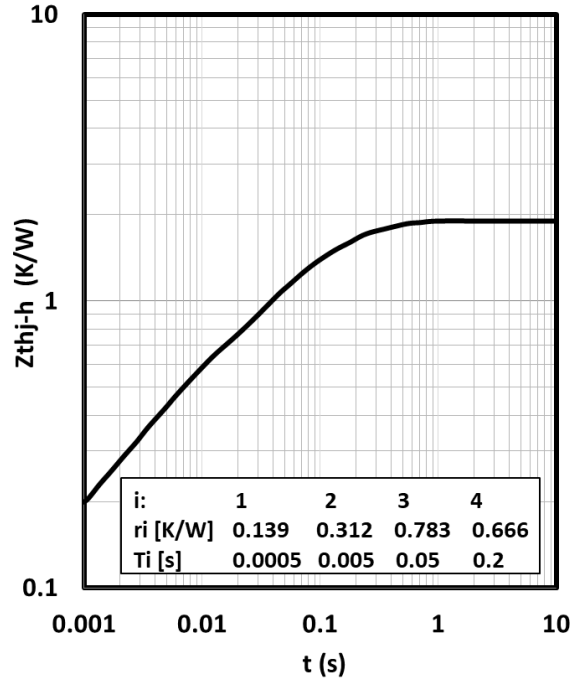

Fig. 6 IGBT (Inverter) Transient Thermal Impedance

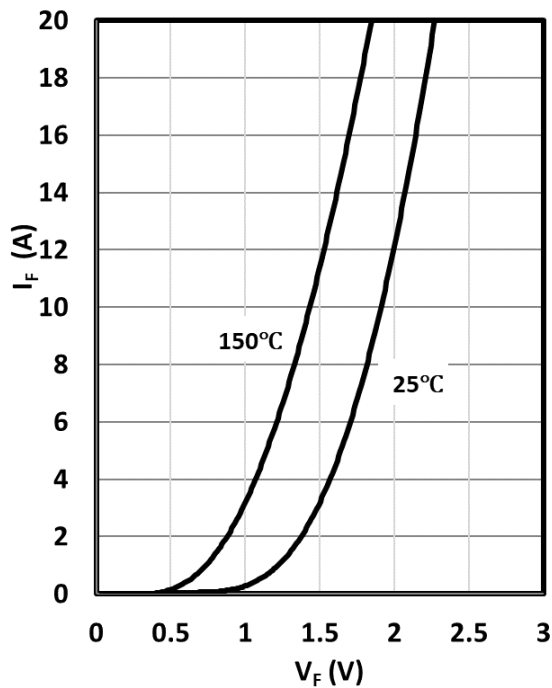

Fig. 7 Diode (Inverter) Forward Characteristics

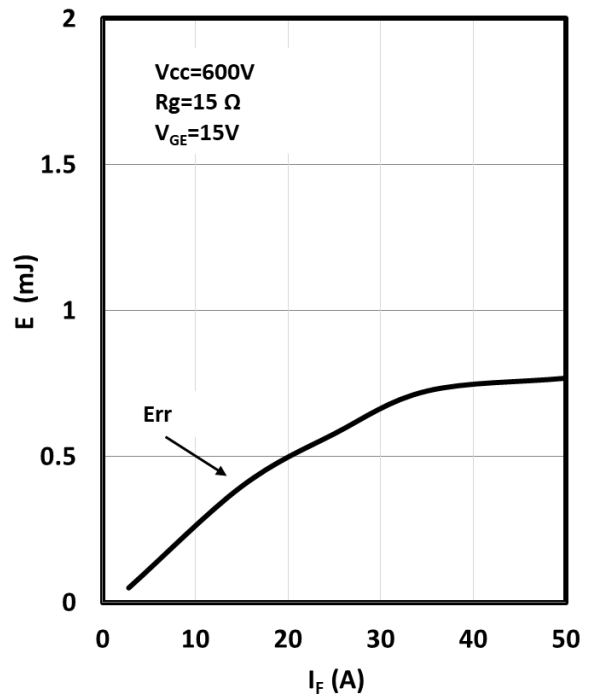

Fig. 8 Diode (Inverter) Reverse-Recovery Loss vs. If

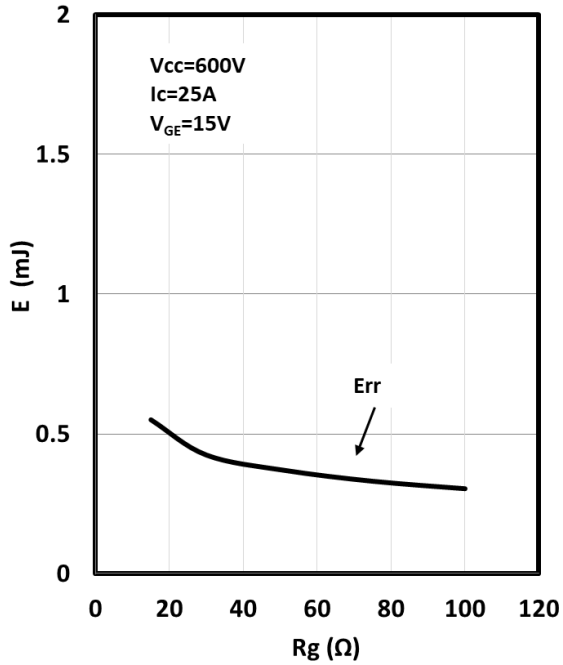

Fig. 9 Diode (Inverter) Reverse-Recovery Loss vs. Rg

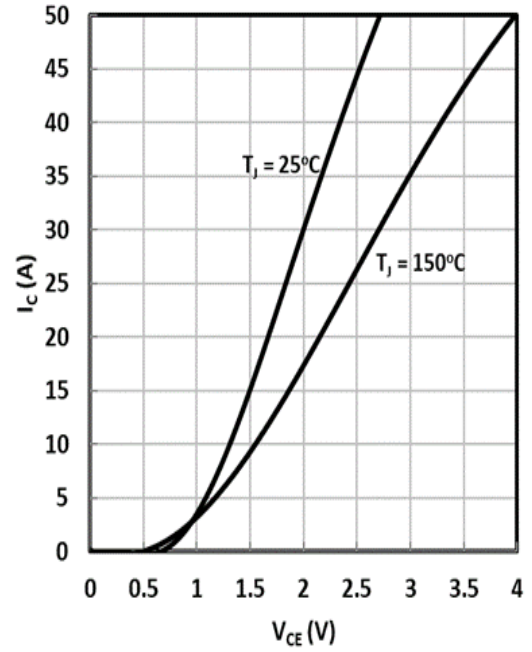

Fig. 10 IGBT (Brake-Chopper) Output Characteristics

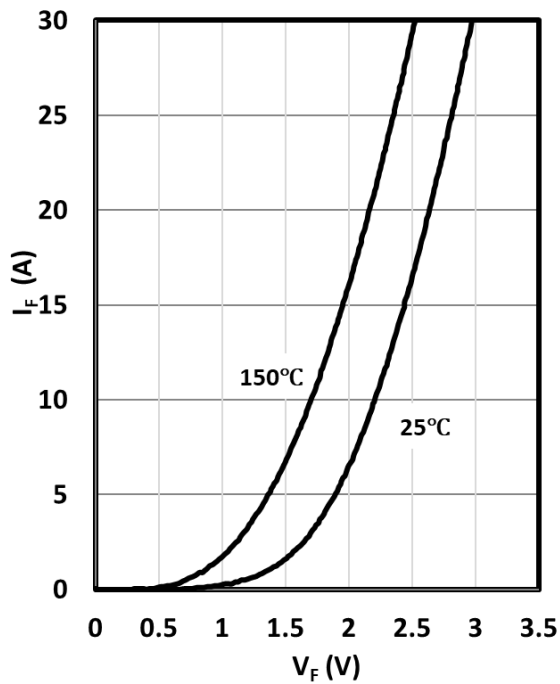

Fig. 11 Diode (Brake-Chopper) Output Characteristics

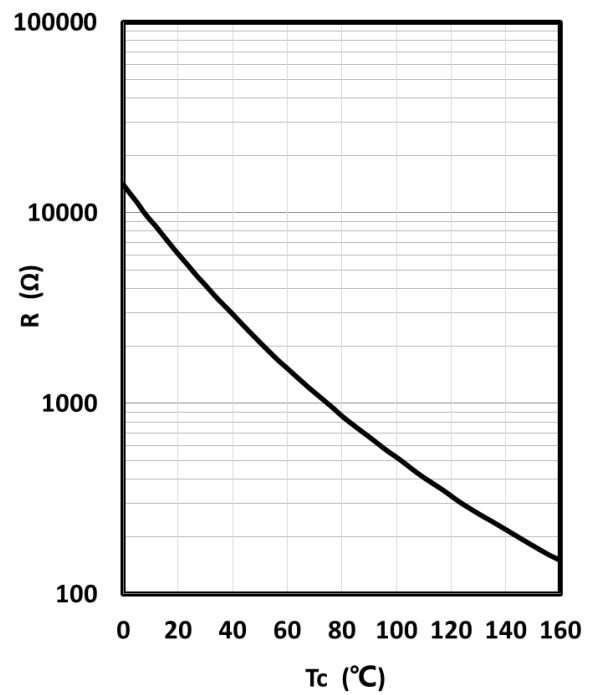
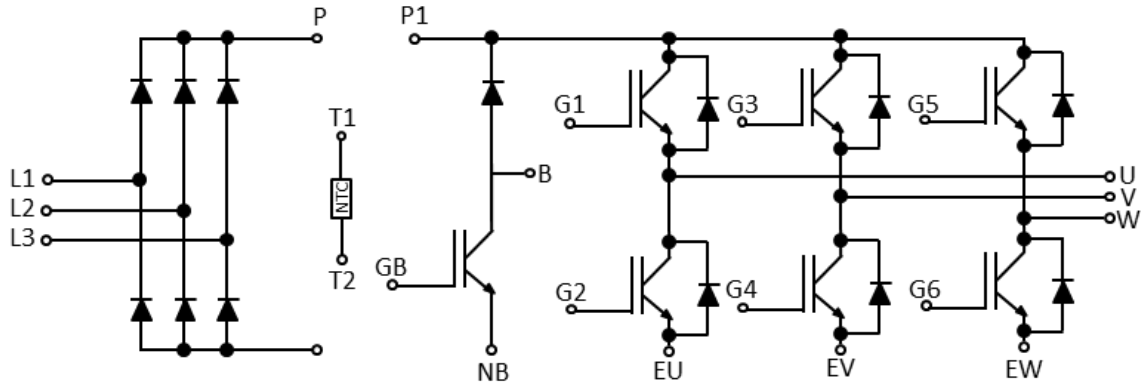
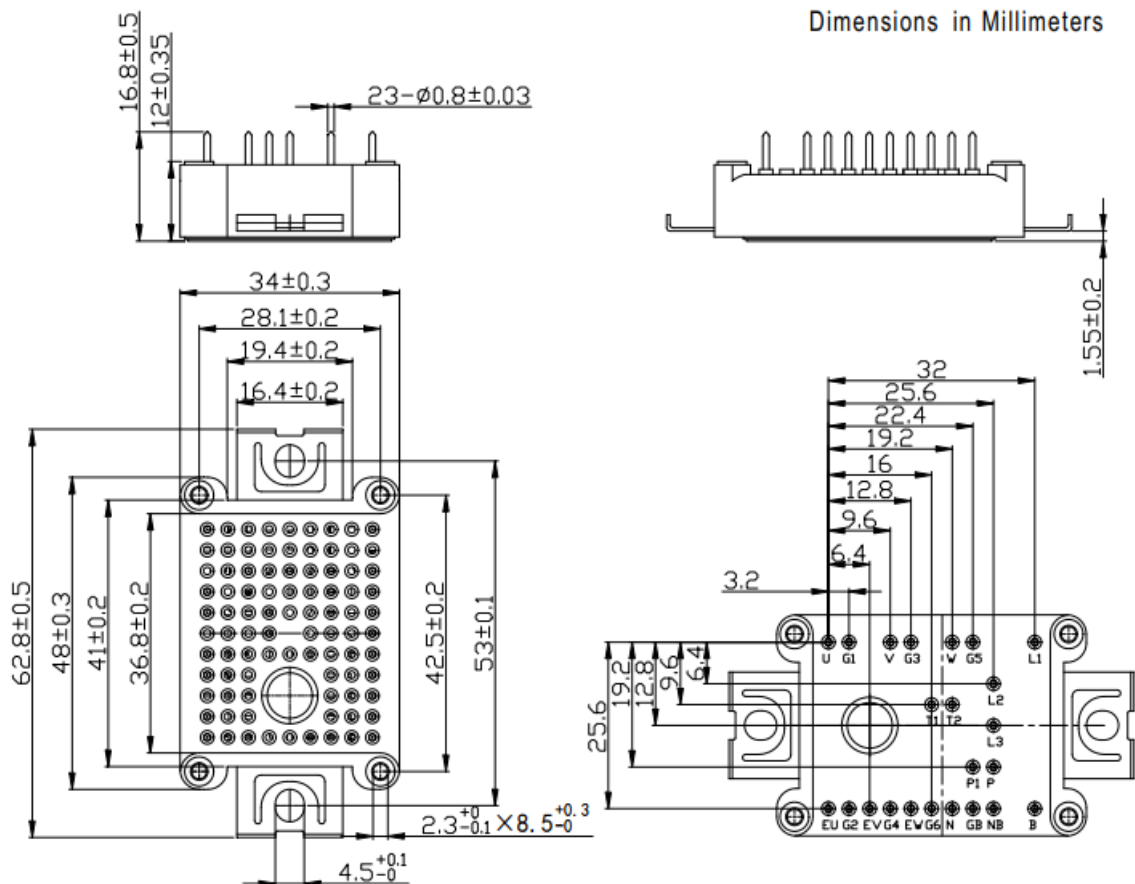

Fig. 12 NTC Temperature Characteristics

• Circuit diagram



• Package Dimensions



Revision history of JG1A25P120FG2 Specification

Version	Change Items	Effective Date
1.00	Initial Release.	20-Nov-20
1.01	Specification updates.	22-Feb-21
1.02	Diode specification updates.	20-Apr-21

Notice

General – This document contains information on a product under development. Information in this document is believed to be accurate and reliable. However, JSAB Technologies does not give any representations or warranties, expressed or implied, as to the accuracy or completeness of such information and shall have no liability for the consequences of use of such information.

Right to make changes – JSAB Technologies reserves the right to make changes to information published in this document, including without limitation specifications and product descriptions, at any time and without notice. This document supersedes and replaces all information supplied prior to the publication hereof.

Suitability for use – JSAB Technologies' products are not designed, authorized or warranted to be suitable for use in medical, military, aircraft, space or life support equipment, nor in applications where failure or malfunction of an JSAB Technologies product can reasonably be expected to result in personal injury, death or severe property or environmental damage. JSAB Technologies accepts no liability for inclusion and/or use of JSAB Technologies' products in such equipment or applications and therefore such inclusion and/or use is at the customer's own risk.

Applications – Applications that are described herein for any of these products are for illustrative purposes only. JSAB Technologies makes no representation or warranty that such applications will be suitable for the specified use without further testing or modification.

Limiting values – Stress above one or more limiting values may cause permanent damage to the device. Limiting values are stress ratings only and operation of the device at these or any other conditions above those given in the Characteristics sections of this document is not implied. Exposure to limiting values for extended periods may affect device reliability.

Terms and conditions of sale – JSAB Technologies' products are sold subject to the general terms and conditions of commercial sale, including those pertaining to warranty, intellectual property rights infringement and limitation of liability, unless explicitly otherwise agreed to in writing by JSAB Technologies. In case of any inconsistency or conflict between information in this document and such terms and conditions, the latter will prevail.

No offer to sell or license – Nothing in this document may be interpreted or construed as an offer to sell products that is open for acceptance or the grant, conveyance or implication of any license under any copyrights, patents or other industrial or intellectual property rights.

Export control – This document as well as the item(s) described herein may be subject to export control regulations. Export might require a prior authorization from national authorities.

Quick reference data – The Quick reference data is an extract of the product data given in the Limiting values and Characteristics sections of this document, and as such is not complete, exhaustive or legally binding.